

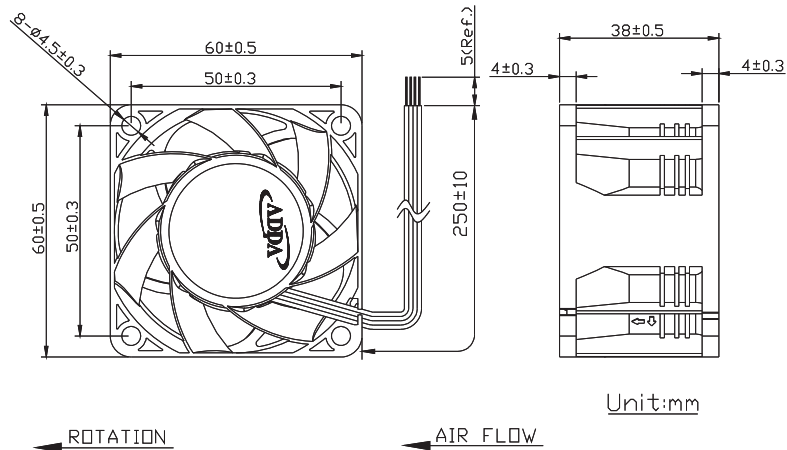

External Dimensions



Frame:Plastic(UL:94V-0)
 Impeller:Plastic(UL:94V-0)
 Lead wire:UL1061AWG26

Specifications(Nominal)

*:Noise is measured at the distance of one (1) meter from the axis of intake.

Bearing type: ◎=Ball ※=Sleeve ●=Hypro bearing

Frame size (mm)	Model No.	Bearing System Type	Rated Voltage (VDC)	Current (A)	Power (W)	Rated Speed (rpm)	Maximum AirFlow (CMM)	Maximum AirFlow (CFM)	Maximum Pressure (InAq)	Maximum Pressure (mmAq)	*Noise Level (dB/A)	Weight (g)
60x60x38	AS06012LB385BB0	◎	12	0.45	5.40	10000	1.058	37.400	1.197	30.400	50.4	143.0
	AS06012MB385BB0	◎	12	0.70	8.40	12500	1.325	46.500	1.790	45.700	56.1	
	AS06012HB385BB0	◎	12	1.13	13.50	15000	1.606	56.700	2.510	63.800	60.9	
	AS06012UB385BB0	◎	12	1.70	20.40	17500	1.857	65.600	3.185	80.900	65.3	



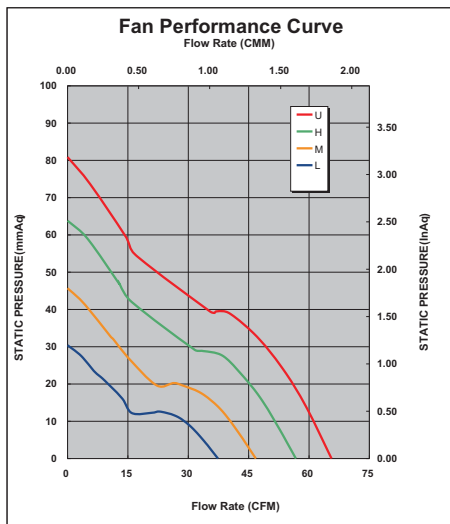

Specifications subject to change without notice.



*Motor protective circuit and third lead wire functions

0	1	2	3	4	6	7	8	9	A	B
	✓	✓	✓							✓

*Safety approvals

				
✓	✓		✓	✓